



Digital Detection Module

Quick Guide

V1.03

1 Packing List

No.	Name	Qty	Unit
1	Digital detection module	1	PCS
2	Screw kit (two M3x6 countersunk head screws and two M3x6 pan head screws inside)	1	Set
3	Power adapter (purchased separately)	1	PCS
4	Bracket	1	PCS
5	Hint label	3	PCS
6	Special statement	1	PCS
7	User manual	1	PCS

2 Product Overview

The digital detection module is a non-contact device for taking wrist temperatures. It has a simple and elegant appearance and features a wide range, high precision, low error, and long temperature measurement distance. It can connect to a face recognition access control terminal through the RS485 interface. The module supports temperature measurement and personnel information binding. It is capable of rapidly identifying personnel information, taking the temperature, and generating an alarm for people with abnormal temperature. In addition, it allows setting a temperature threshold so as to strictly control the access permissions of personnel (a person is not allowed to pass when the person's temperature exceeds the threshold). The module is applicable to application scenes requiring strict temperature measurement such as access control and attendance check.

1 Environmental Conditions

- Indoor use
- Altitude: < 2000m
- Environmental temperature: + 15 °C ~ + 30 °C
- Relative humidity: < 95% RH
- Mains supply voltage fluctuations: ±10%

- Overvoltage category (except cord/plug-connected equipment): II
- Pollution degree of the intended environment: the operational environment should be with less dust to avoid the pollution of blackbody target. (Pollution degree 2)

If the equipment is used in a manner not specified by the manufacturer, the protection provided by the equipment may be impaired.

2 Appearance and size

The actual device appearance shall prevail. The figure below shows the device size.

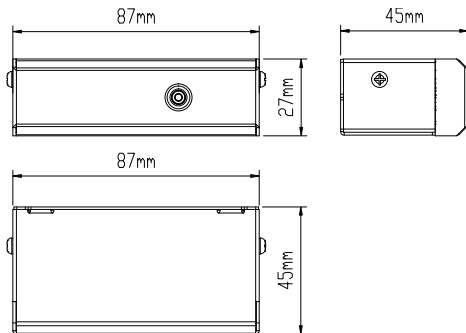

3 Structure and cable

The figure below shows the structure and cable of the device. The actual device shall prevail.

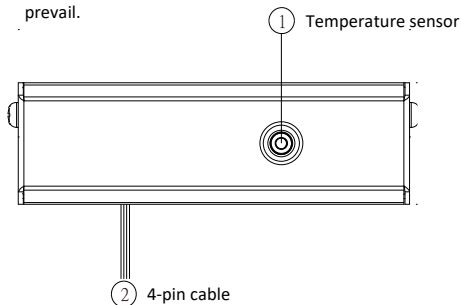

3 Device Installation

3.1 Device Wiring

1 Wiring Embedding

Before installing the digital detection module, plan the layout of the power cable. For the diameter selection for the extension power cable, see the table below.

Table 3-1 Diameter Selection for Extension Power Cables

The device is powered by DC 12V/2A and the lower limit of the operating voltage is DC 9V (12V–25%).				
Wire Diameter (mm)	0.8mm (20 AWG)	1mm (18 AWG)	1.25mm (16 AWG)	1.63mm (14 AWG)
Transmission Distance (m)	18	37	58	99

2 Wiring description

The figure below shows the wiring between the digital detection module and different devices. For the wiring terminal of each device, see the operation manual of the device or consult manufacturers.

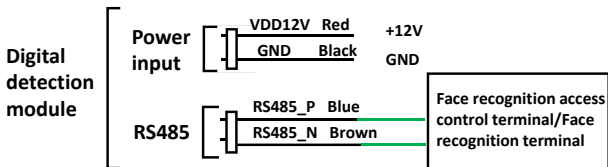

3.2 Tools Preparations

- Antistatic wrist strap or antistatic gloves
- Marker
- Drill
- M8/M6 simple open-end wrench
- Phillips screwdriver
- Slotted screwdriver

3.3 Installation Steps



NOTE!

Before installing the digital detection module, connect the cables between the module and a face recognition access control terminal/face recognition terminal by referring to section "Device Wiring" and sections related to the wiring in the quick guide of the face recognition access control terminal/face recognition terminal.

1 Wall mount

The figure below shows the process of installing the digital detection module on a wall when the module is to be used in combination with a face recognition access control terminal.

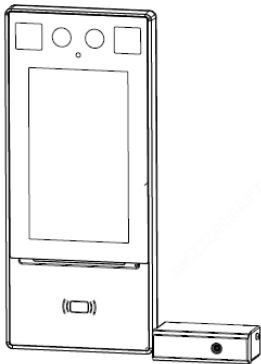
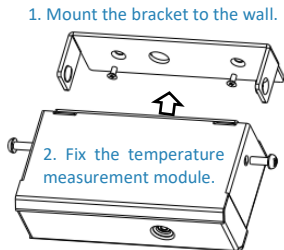

2 Standing pole mount

The figure below shows the process of installing the digital detection module on a standing pole when the module is to be used in combination with a face recognition access control terminal/face recognition terminal.

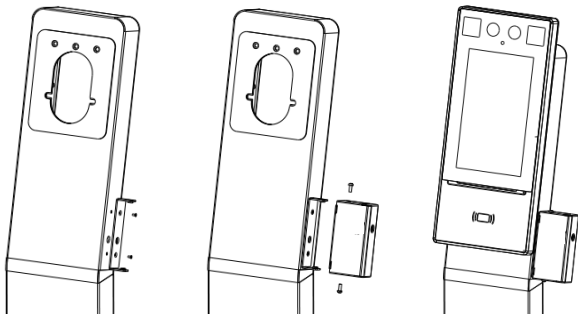

4 Device Startup

1 Device power-on

After the device is installed correctly, connect the power adapter (provided separately) to the mains supply to start the device.

2 Device configuration

Local configuration

When the digital detection module is used in combination with a face recognition access control terminal, you can enable the temperature measurement function on the **Authentication Scene** interface of the face recognition access control terminal.

Tap and hold the GUI for more than 3s. Enter the correct activation password to go to the **Activation Config** interface.

< Authentication scene

Temperature Measurement Only

Face Recognition + Temperature Measurement

Face Authentication + Temperature Measurement

Tip: For more authentication configuration, please log into the web interface.

Mask Detection

Temperature Range 35.5 °C ~ 42.0 °C

Temperature Alarm Threshold 37.3 °C

Tip: Exceeding the alarm threshold is abnormal high temperature.

Save

Temperature value range: [30–45]

Configuration on the Web interface

You can also log in to the Web interface of the terminal and choose **Setup > Intelligent > Advanced Setting** to enable the temperature measurement function.

Temperature Measurement

Temperature Measurem... Measure Forehead Temperature Measure Wrist Temperature

Authentication Failed A... Off On

Temperature Measurem... 35.5 ~ 42

Temperature Alarm Thr... 37.3

Temperature Alert Off On

Temperature Alert Offset 0.3 (Temperature Alert Threshold = Temperature Alarm Threshold - Temperature Alert Offset)

3 Device operations

When the temperature needs to be measured, aim the wrist at the temperature measurement point, at a distance of 1–2.5cm.



Normal temperature

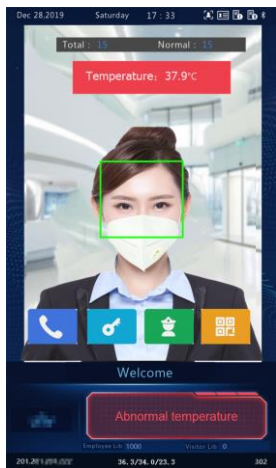

Abnormal temperature

5 Label Attaching

The packing list contains temperature measurement hint labels, which directly tell users the temperature measurement point and distance. After installing the device, attach the label to a proper position of the temperature measurement module.



(1)



(2)



(3)

No.	Label Attaching Description
1	This label is applicable when the temperature measurement module is installed on a standing pole. For details, see "Standing pole mount".
2	This label is applicable when the temperature measurement module is mounted on the wall and the temperature measurement point is downward.
3	This label is applicable when the temperature measurement module is mounted on the wall and the temperature measurement point is outward.  NOTE! As shown in the figure above, the round film on the label aimed at the temperature measurement point must be removed when the label is attached.

6 FAQs

Failure/Symptom	Solution
What should I do if some people's temperatures cannot be taken?	<ol style="list-style-type: none"><li data-bbox="337 193 943 255">1. Check whether the measurement distance is proper. The recommended measurement distance is 1–2.5cm.<li data-bbox="337 273 905 334">2. Check whether the wrist is aimed at the temperature measurement point.<li data-bbox="337 352 938 489">3. Check whether the wrist is covered. The wrist cannot be covered by sleeves, watches, bracelets, or other objects. A person must remove such objects, and then have the temperature taken 0.5–1min later.<li data-bbox="337 507 938 680">4. Check whether the body surface temperature is too low. If a person comes from an outdoor low-temperature environment to the measurement area, the person needs to stay in this area for 5min before the temperature is taken.
What should I do if the temperature measured by the device is inaccurate?	<ol style="list-style-type: none"><li data-bbox="337 707 943 806">1. The device requires preheating after power-on. It enters the optimal temperature measurement state 15 minutes later.<li data-bbox="337 824 905 886">2. Check whether the wrist is aimed at the temperature measurement point.<li data-bbox="337 904 938 1041">3. Check whether the wrist is covered. The wrist cannot be covered by sleeves, watches, bracelets, or other objects. A person must remove such objects, and then have the temperature taken 0.5–1min later.<li data-bbox="337 1059 943 1196">4. Check whether the device is used in an environment with low temperature, high temperature, or strong wind. If yes, deploy the device in an indoor windless environment with the temperature of 15°C to 30°C.

Failure/Symptom	Solution
What should I do when a high temperature alarm is reported during measurement?	<ol style="list-style-type: none"><li data-bbox="339 117 936 323">1. Check whether a person has behaviors that affect the body temperature, for example, getting out of a hot car, doing strenuous exercise, or carrying hot drinks and hot food. If yes, the person needs to stay in the measurement area calmly and have the temperature taken 5 minutes later.<li data-bbox="339 347 923 477">2. Check whether the device is used in an overheated environment. If yes, deploy the device in an indoor windless environment with the temperature of 15°C to 30°C.<li data-bbox="339 500 926 559">3. Use a medical-grade temperature measurement device for a recheck.

Copyright Statement

No part of this manual may be copied, reproduced, translated or distributed in any form by any means without prior content in writing from our company (referred to as us hereafter). The product described in this manual may contain proprietary software owned by our company and its possible licensors. Unless permitted, no one is allowed to copy, distribute, modify, abstract, decompile, disassemble, decrypt, reverse engineer, rent, transfer, or sublicense the software in any form by any means.

Export Compliance Statement

Our company complies with applicable export control laws and regulations worldwide, including that of the People's Republic of China and the United States, and abides by relevant regulations relating to the export, re-export and transfer of hardware, software and technology. Regarding the product described in this manual, our company asks you to fully understand and strictly abide by the applicable export laws and regulations worldwide.

Privacy Protection Reminder

Our company complies with appropriate privacy protection laws and is committed to protecting user privacy. You may want to read our full privacy policy at our website and get to know the ways we process your personal information. Please be aware, using the product described in this manual may involve the collection of personal information such as face, fingerprint, license plate number, email, phone number, GPS. Please abide by your local laws and regulations while using the product.

About This Manual

- This manual is intended for multiple product models, and the photos, illustrations, descriptions, etc, in this manual may be different from the actual appearances, functions, features, etc, of the product.
- This manual is intended for multiple software versions, and the illustrations and descriptions in this manual may be different from the actual GUI and functions of the software.
- Despite our best efforts, technical or typographical errors may exist in this manual. Our company cannot be held responsible for any such errors and reserves the right to change the manual without prior notice.
- Users are fully responsible for the damages and losses that arise due to improper operation.
- Our company reserves the right to change any information in this manual without any prior notice or indication. Due to such reasons as product version upgrade or regulatory requirement of relevant regions, this manual will be periodically updated.

Disclaimer of Liability

- To the extent allowed by applicable law, in no event will our company be liable for any special, incidental, indirect, consequential damages, nor for any loss of profits, data, and documents.
- The product described in this manual is provided on an "as is" basis. Unless required by applicable law, this manual is only for informational purpose, and all statements, information, and recommendations in this manual are presented without warranty of any kind, expressed or implied, including, but not limited to, merchantability, satisfaction with quality, fitness for a particular purpose, and noninfringement.

- Users must assume total responsibility and all risks for connecting the product to the Internet, including, but not limited to, network attack, hacking, and virus. We strongly recommends that users take all necessary measures to enhance the protection of network, device, data and personal information. Our company disclaims any liability related thereto but will readily provide necessary security related support.
- To the extent not prohibited by applicable law, in no event will our company and its employees, licensors, subsidiary, affiliates be liable for results arising out of using or inability to use the product or service, including, not limited to, loss of profits and any other commercial damages or losses, loss of data, procurement of substitute goods or services; property damage, personal injury, business interruption, loss of business information, or any special, direct, indirect, incidental, consequential, pecuniary, coverage, exemplary, subsidiary losses, however caused and on any theory of liability, whether in contract, strict liability or tort (including negligence or otherwise) in any way out of the use of the product, even if our company has been advised of the possibility of such damages (other than as may be required by applicable law in cases involving personal injury, incidental or subsidiary damage).
- To the extent allowed by applicable law, in no event shall our total liability to you for all damages for the product described in this manual (other than as may be required by applicable law in cases involving personal injury) exceed the amount of money that you have paid for the product.

Network Security

Please take all necessary measures to enhance network security for your device.

The following are necessary measures for the network security of your device:

- **Change default password and set strong password:** You are strongly recommended to change the default password after your first login and set a strong password of at least nine characters including all three elements: digits, letters and special characters.
- **Keep firmware up to date:** It is recommended that your device is always upgraded to the latest version for the latest functions and better security. Visit our official website or contact your local dealer for the latest firmware.

The following are recommendations for enhancing network security of your device:

- **Change password regularly:** Change your device password on a regular basis and keep the password safe. Make sure only the authorized user can log in to the device.
- **Enable HTTPS/SSL:** Use SSL certificate to encrypt HTTP communications and ensure data security.
- **Enable IP address filtering:** Allow access only from the specified IP addresses.
- **Minimum port mapping:** Configure your router or firewall to open a minimum set of ports to the WAN and keep only the necessary port mappings. Never set the device as the DMZ host or configure a full cone NAT.
- **Disable the automatic login and save password features:** If multiple users have access to your computer, it is recommended that you disable these features to prevent unauthorized access.
- **Choose username and password discretely:** Avoid using the username and password of your social media, bank, email account, etc, as the username and password of your device, in case your social media, bank and email account information is leaked.

- **Restrict user permissions:** If more than one user needs access to your system, make sure each user is granted only the necessary permissions.
- **Disable UPnP:** When UPnP is enabled, the router will automatically map internal ports, and the system will automatically forward port data, which results in the risks of data leakage. Therefore, it is recommended to disable UPnP if HTTP and TCP port mapping have been enabled manually on your router.
- **SNMP:** Disable SNMP if you do not use it. If you do use it, then SNMPv3 is recommended.
- **Multicast:** Multicast is intended to transmit video to multiple devices. If you do not use this function, it is recommended you disable multicast on your network.
- **Check logs:** Check your device logs regularly to detect unauthorized access or abnormal operations.
- **Physical protection:** Keep the device in a locked room or cabinet to prevent unauthorized physical access.
- **Isolate video surveillance network:** Isolating your video surveillance network with other service networks helps prevent unauthorized access to devices in your security system from other service networks.

Safety Warnings

The device must be installed, serviced and maintained by a trained professional with necessary safety knowledge and skills. Before you start using the device, please read through this guide carefully and make sure all applicable requirements are met to avoid danger and loss of property.

Storage, Transportation, and Use

- Store or use the device in a proper environment that meets environmental requirements, including and not limited to, temperature, humidity, dust, corrosive gases, electromagnetic radiation, etc.
- Make sure the device is securely installed or placed on a flat surface to prevent falling.
- Unless otherwise specified, do not stack devices.
- Ensure good ventilation in the operating environment. Do not cover the vents on the device. Allow adequate space for ventilation.
- Protect the device from liquid of any kind.
- Make sure the power supply provides a stable voltage that meets the power requirements of the device. Make sure the power supply's output power exceeds the total maximum power of all the connected devices.
- Verify that the device is properly installed before connecting it to power.
- Do not remove the seal from the device body without consulting our company first. Do not attempt to service the product yourself. Contact a trained professional for maintenance.
- Always disconnect the device from power before attempting to move the device.
- Take proper waterproof measures in accordance with requirements before using the device outdoors.

Power Requirements

- Installation and use of the device must be in strict accordance with your local electrical safety regulations.
- Use a UL certified power supply that meets LPS requirements if an adapter is used.
- Use the recommended cordset (power cord) in accordance with the specified ratings.
- Only use the power adapter supplied with your device.

- Use a mains socket outlet with a protective earthing (grounding) connection.
- Ground your device properly if the device is intended to be grounded.

Battery Use Caution

- When battery is used, avoid:
 - High or low extreme temperatures during use, storage and transportation;
 - Extremely low air pressure, or low air pressure at high altitude.
 - Battery replacement.
- Use the battery properly. Improper use of the battery such as the following may cause risks of fire, explosion or leakage of flammable liquid or gas.
 - Replace battery with an incorrect type;
 - Dispose of a battery into fire or a hot oven, or mechanically crushing or cutting of a battery;
- Dispose the used battery according to your local regulations or the battery manufacturer's instructions.

Avertissement de l'utilisation de la batterie

- Lorsque utiliser la batterie, évitez:
 - Températures extrêmement élevées ou basses pendant l'utilisation, le stockage et le transport;
 - Pression d'air extrêmement basse, ou pression d'air basse à haute altitude.
 - Remplacement de la batterie.
- Utilisez la batterie correctement. Mauvaise utilisation de la batterie comme celles mentionnées ici, peut entraîner des risques d'incendie, d'explosion ou de fuite liquide de gaz inflammables.
 - Remplacer la batterie par un type incorrect;
 - Disposer d'une batterie dans le feu ou un four chaud, écraser mécaniquement ou couper la batterie;
- Disposer la batterie utilisée conformément à vos règlements locaux ou aux instructions du fabricant de la batterie.

Regulatory Compliance

FCC Statements

This device complies with Part 15 of the FCC Rules. Operation is subject to the following two conditions: (1) this device may not cause harmful interference, and (2) this device must accept any interference received, including interference that may cause undesired operation.

Caution: The user is cautioned that changes or modifications not expressly approved by the party responsible for compliance could void the user's authority to operate the equipment.

NOTE: This equipment has been tested and found to comply with the limits for a Class A digital device, pursuant to part 15 of the FCC Rules. These limits are designed to provide reasonable protection against harmful interference when the equipment is operated in a commercial environment. This equipment generates, uses, and can radiate radio frequency energy and, if not installed and used in accordance with the instruction manual, may cause harmful interference to radio communications. Operation of this equipment in a residential area is likely to cause harmful interference in which case the user will be required to correct the interference at his own expense.

LVD/EMC Directive



This product complies with the European Low Voltage Directive 2014/35/EU and EMC Directive 2014/30/EU.

WEEE Directive-2012/19/EU



The product this manual refers to is covered by the Waste Electrical & Electronic Equipment (WEEE) Directive and must be disposed of in a responsible manner.

Battery Directive-2013/56/EC



Battery in the product complies with the European Battery Directive 2013/56/EC. For proper recycling, return the battery to your supplier or to a designated collection point.