

## Unpacking

Before you begin using the device, please check the version you obtained and ensure that the following items are included in the shipped box:

### Universal Accessories:

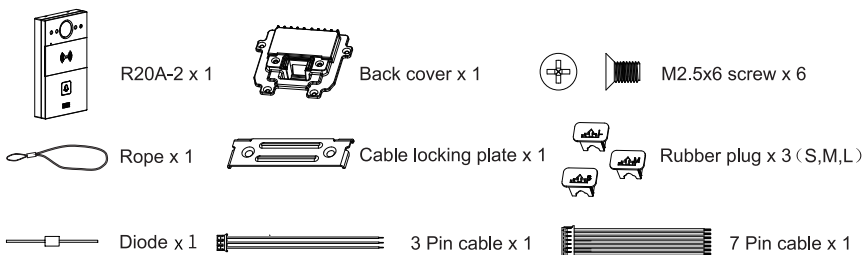

### Wall-mounting Accessories :

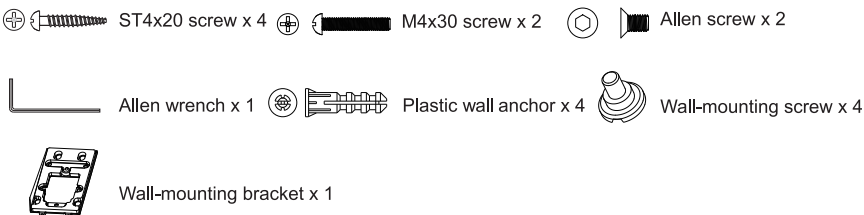

### Flush-mounting Accessories :

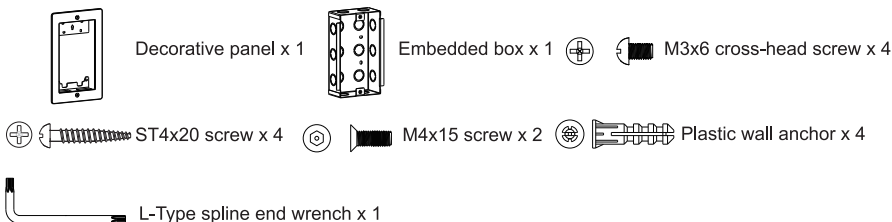

## Product Overview

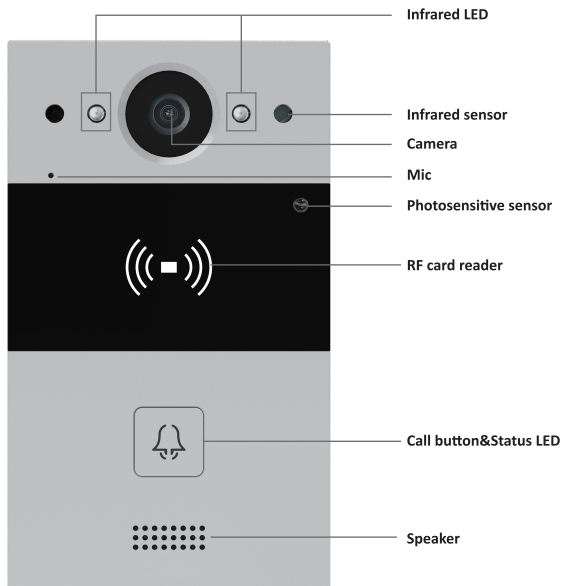

R20A-2

## Installation Environment

Indoor and outdoor installation are supported.

If installing the device outdoors, please don't place device under direct sunlight, it will bring a bad effect or be broken with the high temperature.

If installing the device indoors, please keep device at least 2 meters away from light, and at least 3 meters away from window and door.

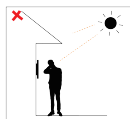

Backlight

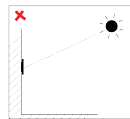

Direct sunlight

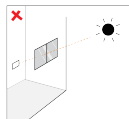

Direct sun through window



Indirect sunlight through window

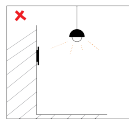

Close to light

## Installation

### On-Wall Mounting

#### Step 1: Wall-mounting bracket Installation

1. With embedded one-gang junction box (86x86 mm or 2x3 inches in size) in the wall.

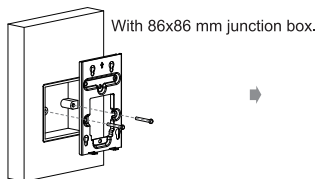

Fix the wall-mounting bracket on embedded box with two M4x30 screws.

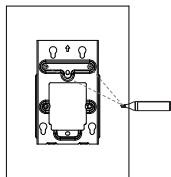

Mark the two holes of the wall-mounting bracket on the wall.

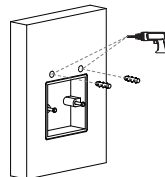

Remove the bracket to drill (5 mm drill bit required) the two marked fixing holes on the wall with a depth of 25 mm. Then insert two plastic wall anchors.

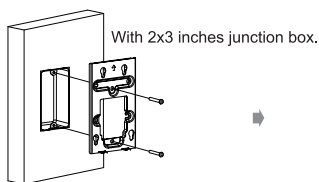

Fix the wall-mounting bracket on the 2x3 inches junction box with two M4x30 screws.

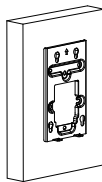

Finish the wall-mounting bracket installation.

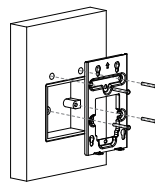

Tighten the wall-mounting bracket on the wall and junction box using two ST4x20 screws and two M4x30 screws.

#### Without 86 embedded box in the wall

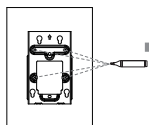

Mark the four holes of the wall-mounting bracket on the wall for the screws.

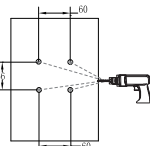

Use a hand drill with 5mm diameter bit to make four 25 mm depth holes in the wall at the marked positions.

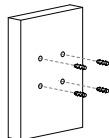

Insert four plastic wall anchors into the holes.

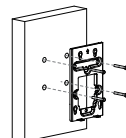

Fix the wall-mounting bracket with four ST4x20 screws.

## Step 2: Back cover Installation

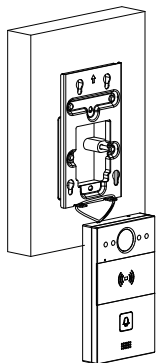

For convenient wiring, hang R20A-2 on the wall-mounting bracket with rope.

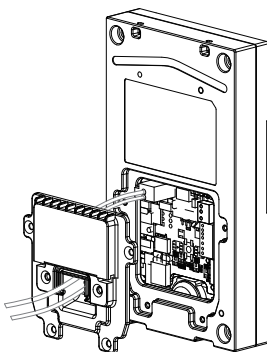

Make cables go through the back cover, connecting to the corresponding interfaces of the main board.

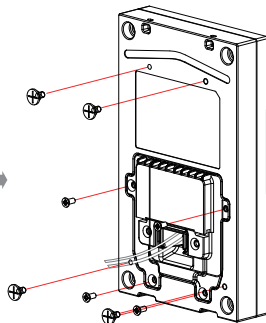

Fasten the back cover with four M2.5x6 screws, then fix four wall-mounting screws on the back of R20A-2.

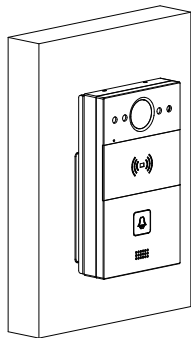

After successful installation, check the stability of device.

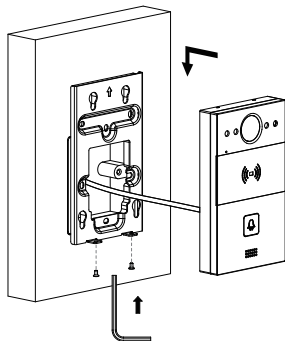

Insert the four wall-mounting screws on the device into the corresponding holes on the wall-mounting bracket, and then press down to slide the wall-mounting screws into the groove. Then use the Allen Wrench to tighten the device with two Allen screws.

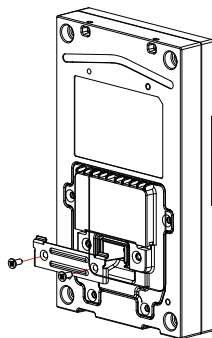

Select a suitable size rubber plug to push all the cables into the back cover. Fix cable locking plate to the back cover with two M2.5x6 screws.

## In-Wall Mounting

### Step 1: Flush Mounting Embedded/Box Installation

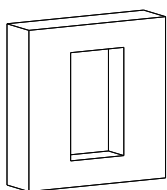

According to the position of the cable, cut a square hole in wall. (height\*width\*depth=180\*101\*50 mm). Note: The size of the hole should be a little larger than recommended value that it can accommodate all needed cables.

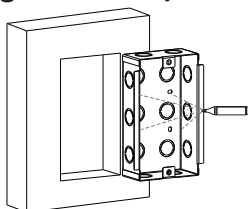

Insert the embedded box into the hole and make sure the cables of the device can route through the cable hole then mark the four screw holes of the wall embedded box on the wall.

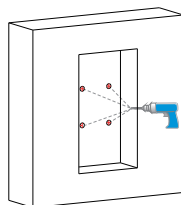

Take down the embedded box then use a 5 mm hand drill to make holes with a depth of 25 mm at the marked positions.

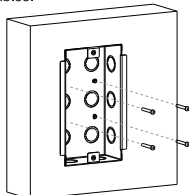

Fix the embedded box with four ST4x20 screws. Then use cement or non-corrosive structural adhesives to fill the gap between the wall and embedded box.

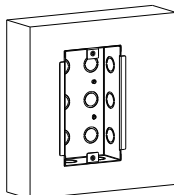

Place the embedded box into the square hole until the edges of which align to the wall and make all cables go through the cable hole.

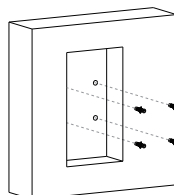

Insert four plastic wall anchors into the holes.

Or you can choose another simple method without fixing ST4x20 screws

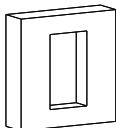

According to the position of the cable cut a square hole in the wall (height\*width\*depth=180\*101\*50 mm). Note: The size of the hole should be a little larger than recommended value that it can accommodate all needed cables.

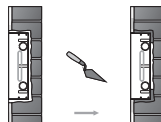

Use cement or non-corrosive structural adhesives to fill the gap between the wall and embedded box. Wait the adhesive material desiccation, go to the next step.

#### Waterproof Tips:

- For flush mounting installation, it is recommended to fill the gaps around the embedded box for waterproofing (to prevent water from entering the back cover of the door phone from the gap).
- For wall mounting installation, it is recommended to lock the wall-mounted bracket and the wall so that the EVA pasted on the bottom of the wall mounting bracket is close to the wall without a gap (to prevent water from entering the back cover of the door phone from the gap).
- Or it is recommended to use rain cover.

## Step 2: Decorative Panel and Back cover Installation

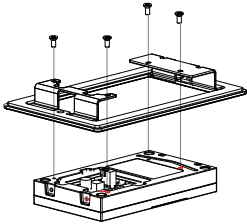

Use four M3x6 Cross-head screws to fix R20A-2 on the decorative panel .

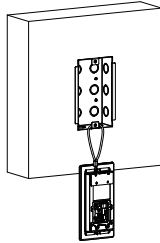

For convenient wiring, hang R20A-2 on the embedded Box with rope.

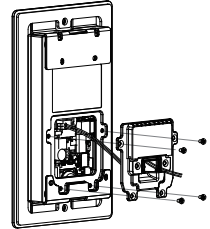

Make cables go through the back cover, connecting to the corresponding interfaces of the main board. Fasten the back cover with four M2.5x6 screws.

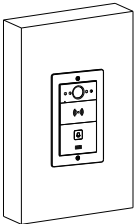

After successful installation, check the stability of device.

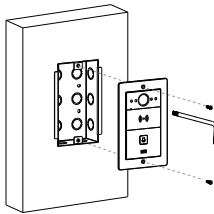

Place the device into the embedded box, then use L-Type Spline End Wrench to tighten the device with two M4x15 screws.

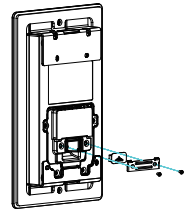

Select a suitable size rubber plug to push all the cables into the back cover. Fix cable locking plate to the back cover with two M2.5x6 screws.

## Device Wiring

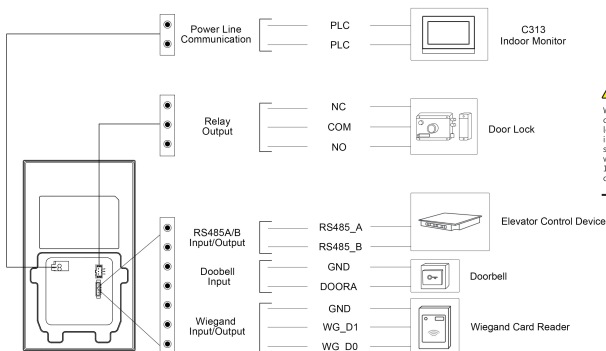

### Warning

When you connect a device containing a coil, such as a relay or an electromagnetic lock, it is necessary to protect the intercom against voltage peak while switching off the induction load. For this way of protection we recommend a diode connected antiparallel to the device.

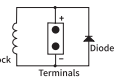

## Application Network Topology

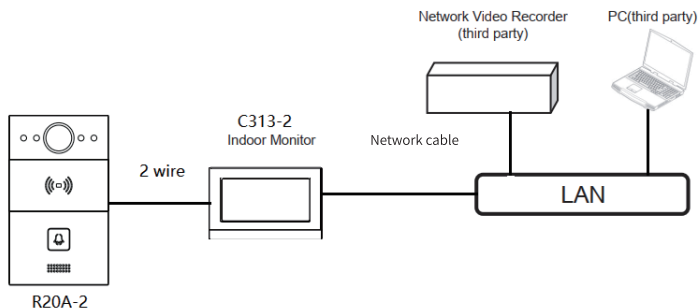

## IP Announcement

1. While R20A-2 starts up normally, hold the call button for several seconds after the Status LED turns blue, voice system will enter IP announcement mode.
2. In announcement mode, the IP address will be announced periodically.
3. Press Call Button again to quit the announcement mode.
4. In announcement mode, phone announces "IP 0.0.0.0" if no IP address is gained.

## Configuration

1. Access the Web UI: Input the IP address into web browser to configure the phone.
2. Account Registration: On web UI, go to the path: **Account -> Basic** page to register account and fill in the account information. (*Please refer to admin guide for more information*)
3. Configure the Push Button: On web UI, go to the path: **Intercom -> Basic -> Push Button** to configure the call number.
4. Configure the code to open the relay: On web UI, go to the path: **Intercom -> Relay -> Relay ID/DTMF** and choose the DTMF code number in corresponding area.

## Operation

### Make a call:













1. Press the call button to call indoor SIP Phone.
2. During the talk, called party can press pre-configured code number to unlock the door.

### Receive a call:

R20A-2 supports Auto Answer by default. Incoming call will be answered automatically.

## Indicators

 Light ON  Light OFF

| Name             | Status   | Description   |                              |
|------------------|----------|---|------------------------------|
| Status indicator | Blue     |    | Normal status                |
|                  |          |  0.25sec →          | Calling                      |
|                  | Red      |  0.05sec →          | Restarting                   |
|                  |          |  0.25sec →          | Network is unavailable       |
|                  | Green    |    | Initialing/Talking on a call |
|                  |          |  0.25sec →          | Receiving a call             |
|                  | Red/Blue |  0.05sec →  0.05sec | Firmware upgrading           |

**Note:** For more LED settings, please refer to R20A-2 webUI: Intercom -> LED Setting.

### Notice Information

Akuvox R20A-2 firmware contains third-party open source software under the terms of the GNU General Public License (GPL). Akuvox is committed to meeting the requirements of the GNU General Public License (GPL) and will make all required source code available.

The source code of software under the terms of GNU GPL can be downloaded online: <http://www.akuvox.com/gpl>.

Information contained in this document is believed to be accurate and reliable at the time of printing. This document is subject to change without notice, any update to this document can be viewed on Akuvox' s website: <http://www.akuvox.com> © Copyright 2021 Akuvox Ltd. All rights reserved.



**AKUVOX (XIAMEN) NETWORKS CO., LTD.**

ADD: 10/F, NO.56 GUANRI ROAD, SOFTWARE PARK II, XIAMEN 361009, CHINA  
[www.akuvox.com](http://www.akuvox.com)



YS20000065